

# SAVE-U : An innovative sensor platform for Vulnerable Road User protection

**Philippe, Marchal**, Faurecia, Centre Technique de Seloncourt - 45, rue de Bondeval - 25400 Audincourt, France

Tel: +33 (0)3 81 36 48 10, Fax: +33 (0)3 81 36 45 20, e-mail: [pmarchal@seloncourt.faurecia.com](mailto:pmarchal@seloncourt.faurecia.com)

**Dariu, Gavrilă**, DaimlerChrysler AG – Machine perception - RIC/AP - DaimlerChrysler Research and Technology - Wilhelm Runge St.11 - 89081 Ulm, Germany

Tel: +49 (731) 505 2388, Fax: +49 (731) 505 4105, e-mail: [dariu.gavrila@daimlerchrysler.com](mailto:dariu.gavrila@daimlerchrysler.com)

**Laurent, Letellier**, Commissariat à l’Energie Atomique - CEA/DRT/LIST/DTSI - 91191 Gif sur Yvette Cedex, France, Tel: +33 (0)1 69 08 55 43, Fax: +33 (0)1 69 08 83 95, e-mail: [laurent.letellier@cea.fr](mailto:laurent.letellier@cea.fr)

**Marc-Michael, Meinecke**, Volkswagen AG - Research Electronic Systems - Brieffach 1776 - 38436 Wolfsburg, Germany, Tel: +49 (5361) 920663, Fax: +49 (5361) 972837, e-mail: [marc-michael.meinecke@volkswagen.de](mailto:marc-michael.meinecke@volkswagen.de),

**Richard, Morris**, Mira Ltd, Watling street - Nuneaton – Warwickshire - CV 10 OTU, United Kingdom

Tel: +44 24 7635 5124, Fax: +44 24 7635 5355, e-mail: [richard.morris@mira.co.uk](mailto:richard.morris@mira.co.uk)

**Mathias, Töns**, SiemensVDO Automotive AG - SV SC RS TG - Osterhofener Strasse 19 - Business park - 93055 Regensburg, Germany, Tel: +49 (941) 790 3264, Fax: +49 (941) 790 5714, e-mail : [Matthias.toens@siemens.com](mailto:Matthias.toens@siemens.com)

## Summary:

Among other initiatives to improve safety of Vulnerable Road Users (VRUs), the European Commission is funding a research project called SAVE-U (IST-2001-34040): “Sensors and system architecture for Vulnerable road Users protection” aimed at developing an integrated safety concept for pedestrians and cyclists. SAVE-U started in March 2002 and will last 3 years. This paper provides an overview of the results of work performed along the first year of the project.

## Introduction

Every year in the EU there are around 9 000 deaths and 200 000 injured victims in road accidents in which pedestrians and cyclists collide with a car. Pedestrian accidents represent the second largest source of traffic-related injuries and fatalities. Clearly, a Europe-wide effort should be made by the relevant influential parties to reduce the number of accidents and to limit the consequences when they occur.

Among other initiatives to improve safety of Vulnerable Road Users (VRUs), the European Commission is funding a research project called SAVE-U (IST-2001-34040): “Sensors and system architecture for Vulnerable road Users protection” (1) aimed at developing an integrated safety concept for pedestrians and cyclists. SAVE-U started in March 2002 and will last 3 years.

This paper describes first the SAVE-U objectives, then provides an overview of the work performed along the first year.

## Objectives

The main objective of SAVE-U is to develop an innovative pre impact sensor platform that will operate three different technologies of sensors simultaneously and will fuse their data for an optimised VRU detection system in all weather and lighting conditions:

- a radar network composed of several 24 GHz sensors working in parallel,
- an imaging system composed of passive IR and vision systems.

After the specification phase, SAVE-U will go on with the development phase to optimise sensors for VRU detection and their related processing Electronic Control Unit (ECU):

- for radar detection, SAVE-U will provide completely redesigned 24 GHz radar sensors equipped with new and dedicated raw data processing algorithms. The main innovation compared to the state-of-the-art will be the improved range and sensitivity of these sensors for a suitable detection of VRU in front of the car.

- for the vision system, SAVE-U is modelling and simulating an “IR sensor” specifically designed for automotive applications that will provide synthesised images for an estimation of VRU IR detection. This issue **(2)** is addressed by means of sensor behavioural modelling and IR scene simulation that reproduce reliable images fully representative of the application.

SAVE-U will also provide an Embedded Image Processor (EIP). The EIP will be composed of a DSP board with a re-configurable module. The embedded board will be able to process IR and visible videos in real-time.

Vulnerable road users protection rely first on the system in charge of obstacle detection. The efficiency of the protection depends mainly on the performance of the algorithms implemented in processing ECUs that have the tasks to detect first obstacles in front of the car and then to classify them as VRU according to specific patterns.

In SAVE-U, algorithms currently under development will be innovative on both levels: detection and classification

- In VRU detection, the innovation in SAVE-U is to propose up-to-date algorithms which will collaborate at a low level with the radar sub-system. High level data fusion alone is not sufficient to provide the required quality and reliability of the target data. Raw sensor data will be exchanged between radar ECU and EIP in order to improve the detection process;
- Another novelty in this field is resulting from merging the IR segmentation results with those delivered by video cameras and implementing these algorithms on dedicated real-time embedded image processing hardware;

The existing image segmentation and classification algorithms for visible camera systems will be adapted to the images of a passive IR camera.

When all the ECUs and new sensors are available, an initial evaluation of the quality of the detection and classification of VRU will take place. For that, SAVE-U will define and develop new validation test procedures, taking in account the selected scenarios and the various test conditions one could find in the driving environment. Specifically, SAVE-U will develop a test rig to evaluate the sensor performance dynamically using real vulnerable road users (test subjects) for true, combined correct characteristics due to the required real behaviour with respect to the three sensor technologies deployed.

At the end of the project, the sensor platform will be installed on two demonstrator vehicles, which will be equipped with VRU protection devices (driver warning and vehicle control strategies). This will allow SAVE-U to evaluate the efficiency of the whole safety system (integrated approach from sensors through to actuators) on VRU protection in true, real world conditions. This evaluation will provide information about the impact of the overall system in the daily life of EC citizens (as vulnerable road users and as drivers) on two aspects:

- efficiency of the vehicle control strategies on the accident severity (e.g. vehicle speed at crash, driver response time).
- acceptance of the driver versus the HMI systems and how HMI helps to better reduce collisions or injuries to pedestrians.

## Partnership

Save-U is a European project developed as a partnership between 4 industrial companies and 2 research organisations with complementary areas of competence and know-how:

- **Faurecia**, the automotive modules supplier that initiated the project, contributes extensive knowledge concerning front-end units, system integration and pedestrian safety/protection.
- **SiemensVDO Automotive** specialises in radars, electronic control systems and the fusion of data collected by multiple sensors.
- Two laboratories of the French **Atomic Energy Commission (CEA)** are responsible for designing special image sensors and the image processing algorithms.  
Research on passive infrared sensors has been entrusted to the **LETI** (Electronics and Information Technology Laboratory) in Grenoble. The **LIST** laboratory in Saclay, specialised in the

Integration of Systems and Technologies, is in charge of the video imaging and image processing systems.

- **MIRA** is an independent automotive technology centre that specialises in safety evaluations and tests. It will develop methodologies to assess the performance of the detection platform and test the vehicles equipped with it. MIRA also has considerable expertise in pedestrian protection.
- **DaimlerChrysler** is a leading vehicle manufacturer with a strong research department. DaimlerChrysler Research will contribute its expertise in on-board system integration and in computer vision algorithms; it will supply one of the two test vehicles.
- **Volkswagen** as a leading vehicle manufacturer will contribute its expertise and will provide a second test vehicle.

The total SAVE-U budget amounts to 8 million Euro.

## Preliminary studies

In order to prepare the definition of the whole sensor platform specification, which was one of the first targets of the project, several preliminary studies were performed.

They cover:

- the definition of the most relevant accident situations involving pedestrians and cyclists extracted from recent accident statistics analysis,
- the analysis of the appearance of the dressed human body for the considered sensing technologies,
- the evaluation of selected VRU protection systems (e.g. driver warning, braking).

For a recent survey on pre-impact sensing for pedestrian detection, using various sensors (video, radar, laser scanner), see (3).

## Accident statistics analysis

For the scenario analysis, SAVE-U performed an in-depth search related to existing pedestrian/cyclist accident studies. A variety of accident data were covered, from national European level (i.e. Germany, France) to EU level, including comparative data on various world regions (i.e. EU, US, Japan). Most data was derived from the last decade, with statistics as recent as 2001.

The resulting analysis first dealt with aggregated VRU accident figures, and then investigated single factors for the pedestrian and bicyclist group: age distribution, collision opponent, initial- and collision speeds, time-of-day, weather conditions, accident location and vehicle contact zones. Thereafter, two in-depth studies on pedestrian and pedestrian/bicyclist accidents were summarised from Germany and US, respectively.

The main results are the following observations:

- Pedestrians account for the second largest number of traffic accidents world-wide, after vehicle occupants.
- The fatality rates for all traffic participant groups in the EU countries have decreased over the past decade. Pedestrian fatality has decreased most among all groups. Meanwhile, EU has achieved the higher degree of pedestrian safety compared to the US and Japan.
- Pedestrians and bicyclists of all ages are impacted, some studies show increased impact for the younger (pedestrians/bicyclists) and elderly (pedestrians).
- Passenger cars are the collision opponents in the large majority of pedestrian accidents in Europe. For bicyclists, the passenger car group is less represented in accidents and a sizeable portion of accidents involve (light) trucks as collision opponent.
- The large majority of pedestrian accidents occur at collision speeds below 50 km/h. The vehicle speed interval where most improvement could be achieved with respect to pedestrian injury level is 30-50 km/h. Collision speeds involving bicyclists are somewhat higher.
- For light to medium-severe pedestrian accidents (the majority of all accidents), the secondary impact with the street is comparably often the source of injury as is the primary impact with the vehicle.
- A large majority of pedestrian accidents happen during daytime conditions (in France and Germany). A significant minority of fatal accidents however occurs at night. Aggregated data from Europe and US appears to paint different pictures regarding the influence of lighting conditions.

- A large majority of non-motorist accidents occur during normal (dry) weather conditions.
- The vast majority of pedestrian accidents involves an urban area. For fatal pedestrian accidents, the rural area increases in relevance.
- Intersections account for a minority of the pedestrian and bicyclist accidents.
- In the large majority of the pedestrian and bicyclist accidents, the primary contact zone involves the frontal area of the vehicle. In most bicycle accidents, the bicyclist come predominantly from the right, from driver's point of view.
- The large majority of pedestrian and bicyclist accidents involves a vehicle going approximately straight ahead on the road (i.e. no turns at intersection or backing out). For this case, the number of accidents involving the pedestrian or bicyclists crossing the vehicle path laterally is 3-4 times as large as the number of accidents involving the pedestrian or bicyclist heading in the same direction as the vehicle.

### **Evaluation of human body sensing technologies**

Another part of the work for the definition of specifications was directed towards the evaluation of human body sensing technologies. In a first step, SAVE-U has conducted a survey about the state of the art of existing techniques to detect a human body in the environment and what methods are already available in order to distinguish pedestrians and cyclists from other obstacles from passive sensors (video and IR) to active sensors methods (laser, radar). It was shown that success or failure of a pedestrian safety system, from a technical point of view, will very much depend on the rate of correct detections versus false alarms that it produces, at a certain processing rate and on a particular processor platform. The bibliography, which was stopped on July 2002 shows that the best result gives a false positive rate of 1 per 2.8 hours, for a detection rate of 90%. Integrating results over time by tracking will improve this figure somewhat, but this effect will be offset by the lower filter ratios of the shape and texture components which, in practice, cannot be considered independent. Based on this, the false positive rate will need to be reduced by at least one order of magnitude in order to obtain a viable pedestrian system, while maintaining the same detection rate.

Then SAVE-U performed the analysis of the signals received by sensors from Vulnerable Road Users, in particular pedestrians dependent on different clothing and in different environment. The analysis took into account the 2 imaging principles employed in SAVE-U: passive IR (typ. 10  $\mu\text{m}$  wavelength) and visible light.

The purpose was to have a better understanding on the way a colour video camera and an infrared camera will respond to different environmental conditions faced by drivers. The main parameters (e.g. lighting conditions, ambient temperature, colour and thickness of clothes) have been identified and, to have a better control on their variations, some tests were realised in an indoor environment to simulate specific scenarios when it was possible (i.e. scenarios without rain, snow or fog).

As an example, some images shot during these tests are presented hereafter. Figure 1 (left: colour camera, right IR camera) shows how is seen a pedestrian wearing light colour clothes by a clear night enlightened by car dipped headlights and with a front headlight.



**Figure 1: Car back-lighting (simulation of a pedestrian wearing light colour clothes by a clear night enlightened by car dipped headlights and with a front headlight)**

Figure 2 (left: colour camera, right IR camera) shows how is seen a pedestrian wearing a short during a hot and sunny day with ground reverberation.

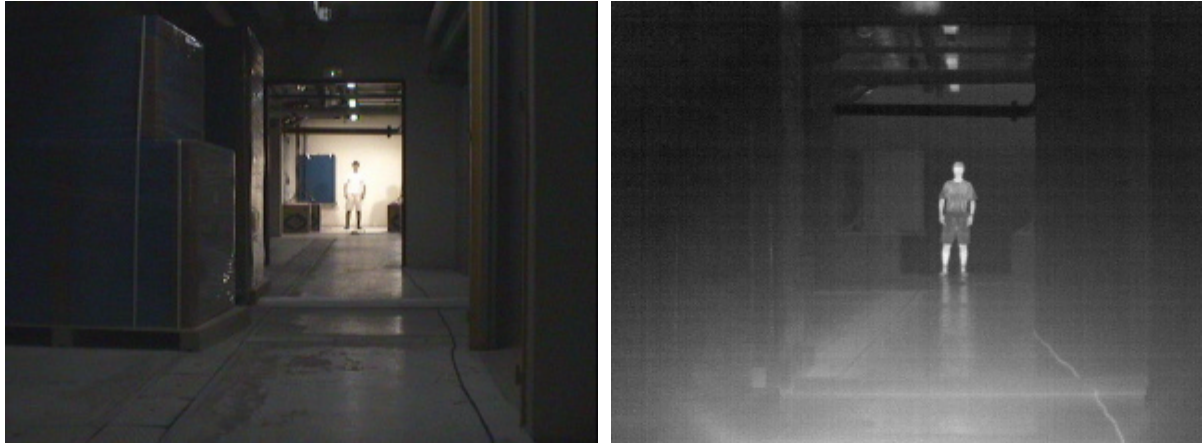

**Figure 2: Convector (simulation of a pedestrian wearing a short during a hot and sunny day with ground reverberation)**

Pictures from colour or white and black cameras are the ones usually used for image processing. What they perceive is near from the human visual sense, but they suffer from back-lighting and insufficient exposure to light. Nevertheless, a camera with logarithmic response could greatly improve this last point.

Adding an infrared camera to a colour video camera will bring some benefit to pedestrian detection because pictures quality is good enough for image processing, and because it can work by night and sequences are not perturbed by car back-lighting. But, because of time drift, one cannot expect having the absolute temperatures and use them like extra information to dismiss some parts of the images because they would not be in the good temperature range for being a pedestrian. So, the slight differences in grey levels induced by clothes types will not affect the results of pedestrian detection because it will be totally based on image processing.

Conclusion of this work was that the use of an IR camera in addition to a colour video one could greatly improve the system.

### **Strategies to protect vulnerable road users**

The third main input for the definition of the SAVE-U sensor platform specifications was the identification of strategies that could be implemented by car manufacturers on vehicles to protect vulnerable road users in front of the vehicles.

Three different stages of protection were taken into consideration:

- Early detection of vulnerable road users
- Identification of suitable driver warning and vehicle control strategies in order to avoid a crash, e.g. emergency braking in case the driver does not react.
- Identification of concepts for the protection of vulnerable road users in case a crash cannot be avoided.

Table 1 provides an overview of what is currently under consideration regarding protection of vulnerable road users. The different actuators were evaluated according to six criteria:

- Reversible/ Irreversible/ No Deployment
- Passive/ crash-active/ preventive methods
- Protection of VRU or occupants
- Protection potential from accident statistics point of view
- Avoidance or reduction of first impact
- Avoidance or reduction of secondary impact (including tertiary impact)

Current sensor systems for pre-crash applications or driver assistance system in general (e. g. cameras with image processing and radar sensors) have high performance, but the requirements in

this field are much higher. Because the false alarm rate is still too high, SAVE-U will demonstrate only reversible protection systems.

Protection systems	Braking distance reducing	Driver Warning	Exterior Airbag	Hood lifting (Reversible Technology)	Active Bumper	Windshield airbag	Enhancement of driver's view	Pedestrian warning	Seat-Belt Tensioner (electrical)	Night Vision
Reversible/ Irreversible/ No Deployment	Rev. +	Rev. +	Irrev. -	Rev. -	Irrev. -	Irrev. -	No +	Rev. +	Rev. +	No +
Passive/ Crash-active/ Preventive Method	Prev.	Prev.	Not possible due to 100% fault safe sensor requirement	Crash-active	Not possible due to 100% fault safe sensor requirement	Not possible due to 100% fault safe sensor requirement	Pass.	Prev.	Crash-active	Pass.
Protection of VRU or Occupants	VRU +	VRU +		VRU +			VRU +	Occ. -	VRU +	
Protection potential from accident statistics point of view	++	+		+			+	0	+	
Avoidance/ reduction of first impact	++	+		+			+	0	+	
Avoidance/ reduction of secondary impact	++	+	0	0	0	+				
<b>Total:</b>	<b>8+</b>	<b>5+</b>		<b>2+ *</b>			<b>5+</b>	<b>5+</b>	<b>0</b>	<b>5+</b>

**Table 1 : Overview about protection systems and their protection potential. Legend: “+”: positive evaluation level, “0”: neutral evaluation level, “-“: negative evaluation level. \*) valid for reversible variant only.**

The evaluation indicates that automatic deceleration, driver warning and pedestrian warning are potential candidates for SAVE-U demonstrators.

### Specifications of the SAVE-U sensor platform

The first major result of SAVE-U is the establishment of the specification of the sensor platform and is introduced in the next paragraphs.

#### Sensor platform

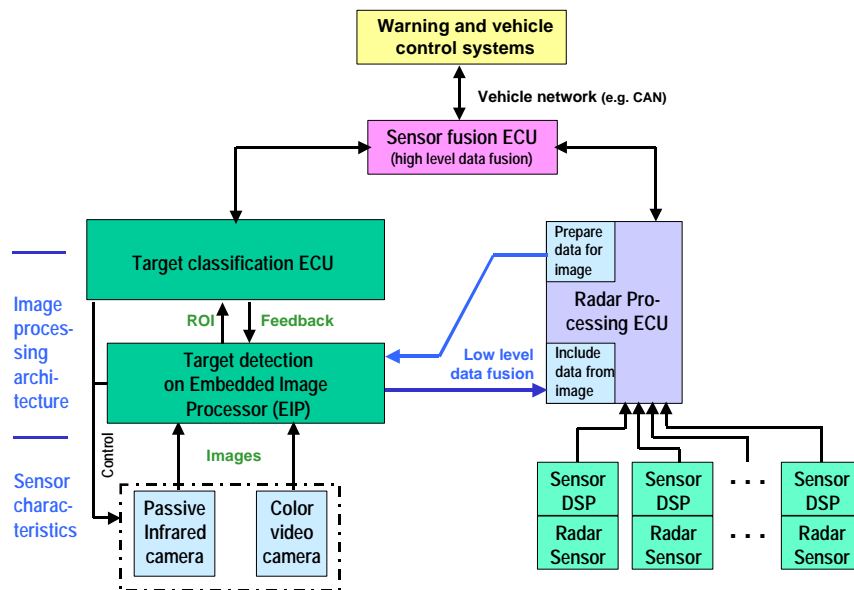

**Figure 3 : System architecture**

The SAVE-U project will set up an optimised sensing platform to detect Vulnerable Road Users at a sufficient distance with 3 sensing technologies: IR vision, colour visible vision and 24 GHz radar

network. A fusion between those data will be made to give a reliable information to the car system: "Is a VRU in front of the car?" and "what are its characteristics?". That information will then be provided to VRU protection systems for action. See Figure 3. However, the research will not focus on the actuator part.

### Overall sensing platform area

The detection area is distributed between sensors as shown on Figure 4.

Sensors are organised in the following way:

- Radar network composed of four or five single beam 24 GHz short-range radar sensors (SRR). These sensors will have overlapping detection areas. Multi-sensor processing algorithms (basic and advanced multi-lateration: calculation of angle from range information) will be developed in order to operate the individual single beam sensors in the radar network
- Colour vision and IR vision systems will generate a vertical view of detection area in most weather conditions (including night).
- Because the three sensors have overlapped coverage area, two fusion levels will be available: low level to focus detection on Region of Interest provided by other sensors and high level to confirm the potential targets classified by the system.

Because classification is mainly based on vision system, the classification range is limited to 25m but thanks to radar system the detection range is extended up to 30m.

The main characteristics of the detection area are 8 meter width (symmetrical to vehicle), to 30m, in front of the car. This area corresponds to the one where a VRU will be seen for the first time: the classification area will be smaller and closer to the vehicle.

The expected results at the end of the project are the detection of up to 3 pedestrians and 2 bicyclists, with a minimal refresh output rate of 5 Hz.

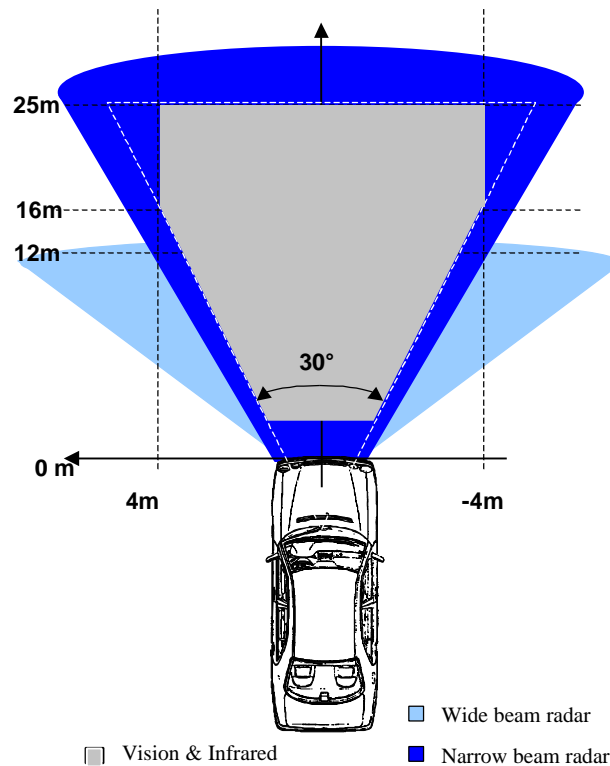
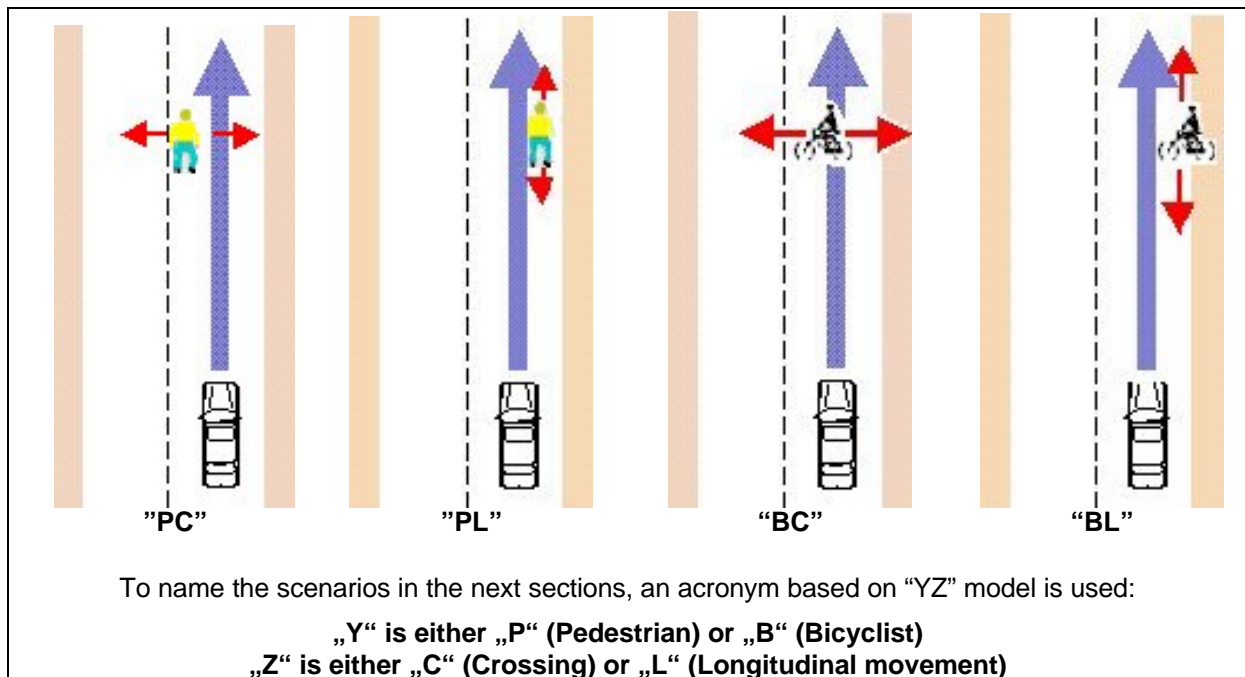

**Figure 4: Sensing area for each sensor**

(not at true scale)

## Selected VRU accident scenarios

Based on accident statistics analysis and on technical feasibility, the SAVE-U consortium selected four scenarios to be addressed within the project. The four selected SAVE-U scenarios are shown in Figure 5.



**Figure 5: Four selected SAVE-U scenarios**

All scenarios involve a straight or slightly curved road onto which a pedestrian or bicyclist is/appears within the driving. Although Figure 5 does not depict an intersection, whether an intersection exists or not, should not be considered part of the scenario description; what is captured in Figure 5 is the relative geometry of the vehicle and the VRUs. Thus for example, scenario "PC" covers both the case of a pedestrian walking on a marked pedestrian crossing ("zebra") at an intersection and the case of a pedestrian crossing the road at an arbitrary, unmarked location.

Pedestrians can be both adults and children and can be walking at various speeds (i.e. from running to standing still). We will restrict ourselves to pedestrian standing/walking approximately upright, and not lying down on the pavement.

The SAVE-U scenarios consider VRUs in front of the vehicle, and for example do not include the case of backing out from a parking spot.

The SAVE-U scenarios do not involve constraints on weather or time-of-day conditions. In fact, the aim of the consortium is to develop sensor systems that handle "good" and "bad" weather conditions (i.e. dry, rain, fog, snow) and various times-of-day (day, twilight, night). However, a certain system degradation is expected with reduced visibility conditions.

The maximum vehicle speed in SAVE-U scenarios is set to 40km/h, which represents about 10km/h above the current limit to State of the Art (30km/h in Protector).

## Sensor fusion ECU

The sensor fusion ECU is the heart of the SAVE-U sensor platform due to its interfacing function. It will collect data from both image and radar processing and allow the sensors of different technologies to interact. By processing the high level data fusion algorithms and optimizing tracking routines, this ECU will compute the relevant objects (classified VRUs in front of vehicle, distance and time to impact, relative speed...) and transfer information to the protection system in order to suitably react (warning and control strategies to avoid a crash / active system in case the crash cannot be avoided).

In turn, the sensor fusion ECU will be directly linked to the vehicle network to acquire vehicle information (for example speed, acceleration, yaw angle, inclination, roll angle, steering angle). Some of these data will then be retransmitted to the image and radar processing ECUs for integration into internal calculations.

### Communication for low level fusion

Between Radar ECU and EIP ECU, data will be exchanged (refer to Figure 3). It is the low level data fusion. The main list of information that each unit can provide to the other or needs from the other is given hereafter:

#### From video part

Thanks to tracking function, EIP will provide, for each target, a label that identifies the potential VRU. Attached to this label, will be some parameters:

- Azimuth information ( $\alpha$ )
- Depth rough estimation ( $\rho$ ). With a monocular vision system, this parameter is weak but may help radar focus.
- 2D-size estimation (width, height). Because it is linked to the depth estimation, it is also a weak parameter
- Speed estimation ( $V_x, V_y$ ). Derived from both azimuth and radial speed coming from radar measurement.

#### From radar part

Because radar networks implements a tracking algorithm, targets are labeled and have parameters:

- Rough azimuth ( $\alpha$ ). Due to technology, this weak parameter will be limited to 'left', 'middle', 'right' area of detection in the mid range area and the azimuth in the short range area will be estimated by multilateration.
- Depth ( $\rho$ ). It is the main characteristic of radar detection.
- Speed estimation ( $V_x, V_y$ ), derived from radial speed measurement by the radar sensor and the azimuth position coming mainly from video part.

### Protection systems

The characteristics of VRU protection systems that will be installed on demonstrators have an impact on the detection requirements. The selected ones, which are automatic braking and driver warning are detailed hereafter:

#### Automatic braking

From an accident research point of view the braking is the most efficient protection system for vulnerable road users.

Reduction of severity of injuries is directly related to the decrease of the collision speed (see Figure 6). Especially in the region of 30 km/h up to 50 km/h, where the gradient of the curve has its maximum, the cumulative frequency of MAIS 2+ (i.e. an injury severity equal to or higher than MAIS2) casualties is nearly linear proportional to the collision speed (**4**). This interval is an operation area with a high potential, where it is expected to get the maximum of reduction in severity of injuries.

The objective of the SAVE-U demonstrators will be to brake with brake pressures in the comfort braking area instead of emergency braking. This corresponds to decelerations of  $-1 \text{ m/s}^2$  up to  $-4 \text{ m/s}^2$ . The SAVE-U braking system will not be able to brake with  $1 \text{ g}$  ( $1 \text{ g} = -9,81 \text{ m/s}^2 =$  acceleration of the gravity), which is a common value in emergency braking systems. The braking concept on the SAVE-U demonstrators bases on reversible actuator methods. This includes that rare false alarms (i.e. false automatic braking), will not affect/ endanger third parties in the traffic (e. g. following vehicles).

The advantage of using braking as an actuator system is twofold. First, the impact of the primary impact (so-called collision) will be reduced dramatically, as it was illustrated in the figures above. In addition to this, the second advantage is, that braking is the only protection method which reduces also the impact of the secondary impact (collision VRU versus street) and third impact (collision VRU versus second vehicle).

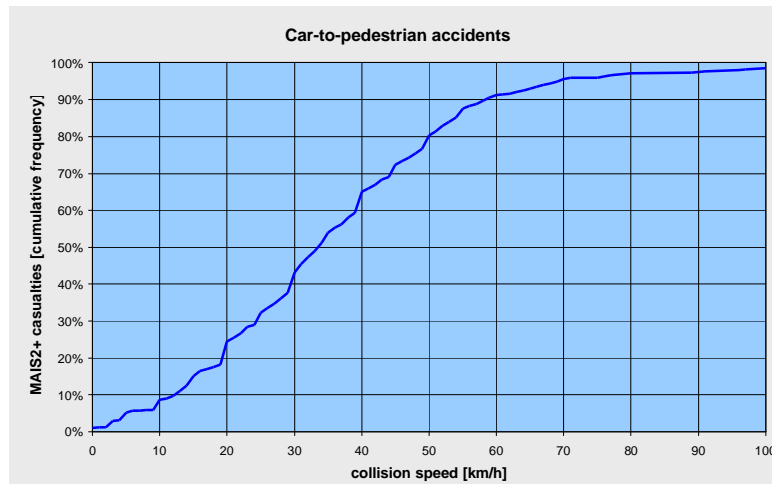

**Figure 6 : Cumulative frequency of MAIS2+ casualties versus collision speed.**

A big advantage of comfort braking is that it is a reversible method, of course, and the deployment can include different brake pressures to find the optimal braking course with respect to measurement accuracies of the trajectory, and other technical parameters.

#### Driver warning strategies

A basic principle in the community of driver assistant system engineers is: "It is much more effective for both pedestrian and host vehicle to avoid a crash than to reduce the accident severity of a crash".

Following this rule, in many critical road situations the possibility of the collision can be minimised if the car driver is warned early enough. Then the driver is asked to react directly: The eyes will be directed to the front immediately. Collision has a good chance to be avoided with manoeuvre-driving.

The warning can base on three methods: acoustical, optical and haptical. The today's view is that the DaimlerChrysler demonstrator will have acoustical and optical warnings on board. For the Volkswagen demonstrator, haptical warning is a potential candidate, which can be integrated, because the wake-up effect is very important and helpful. Haptical warnings can be provided from two sources to the driver:

- Vibrating steering wheel.
- Hard braking jerk.

### **Database of VRU images**

Another important output of the SAVE-U project is the large database of VRU images. The VRU database is quite unique world-wide, because of its huge size: it contains more than 14.000 images and 180 sequences recorded with infra red and colour video cameras in real road situations. Examples of recorded images are shown on Figure 7.



**Figure 7: Examples of collected infra-red images**

Part of this database has been enriched with „ground truth“ data, where “true” VRU locations have been labelled by a human operator. This process consists in outlining the VRU object contours in images and in establishing temporal correspondence across the images of a sequence (see Figure 8).

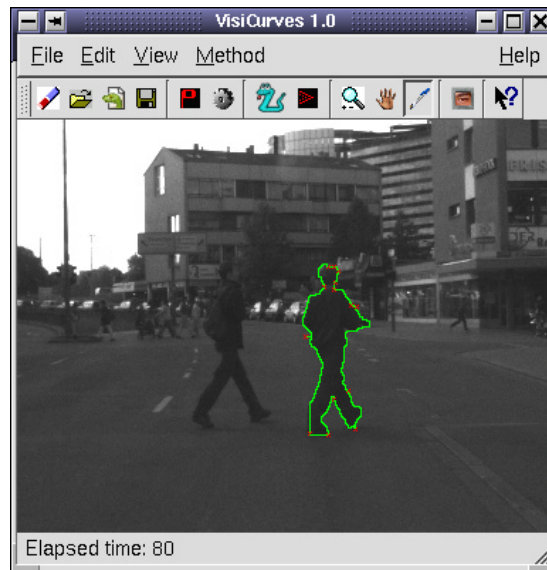

**Figure 8: The VisiCurve Tool for Computer-Assisted Image Labelling – Main Window**

The benefits of this database are twofold. First, it provides a wealth of training data for statistical pattern matching techniques. These “learn” the VRU appearance from examples; which is important, since good prior, explicit models are hard to define. Second, it allows to evaluate system performance on a truly large data set, so that the results can be considered representative of the true physical traffic situation.

This unique image database is available for the research community via the SAVE-U web site.

## Ongoing work

### Strategy for low level data fusion

At the moment, sensors suppliers are collaborating to refine the way to make the sensors (video and radar) work together. To do so, they have defined a calibration procedure between the two sensor systems in order to enable a cooperative work and then to build a strategy for data fusion.

The objective is to find a geometrical correspondence between the radar and the video coordinates systems. Then, a fusion strategy will be chosen that takes into account the results (precision and uncertainty, constraints) of the previous task. Therefore the functional blocks for low-level data fusion will be defined.

### Image sensor and image processor development

The main activity in this domain is the development of the low level image processing. The work concentrates mainly on image compensation techniques in order to provide ROIs (Region Of Interest) that will be forwarded to the classification stage.

Looking at a scene taken by a video camera mounted on a vehicle, it appears that main changes are due to vehicle global motion, while minor changes are rather related to other moving objects such as cars, bicycles or pedestrians. The compensation technique consists in estimating the camera induced 2D motion field and use it to align two successive images. So regions with secondary motions will be badly corrected and thus detectable as illustrated on Figure 9 to Figure 12.

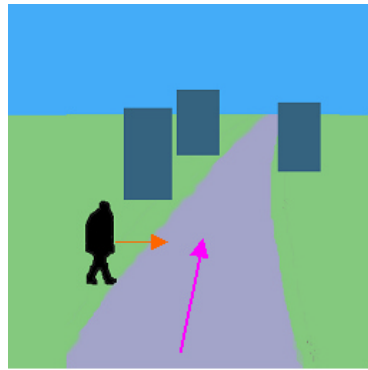

Figure 9. Image at t with car and pedestrian motions

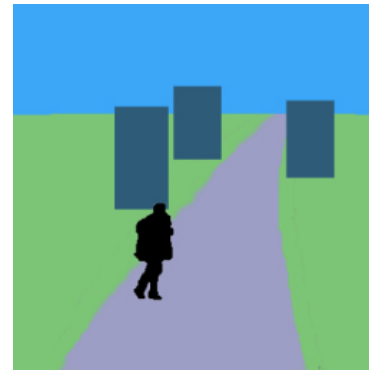

Figure 10: Image at t+1

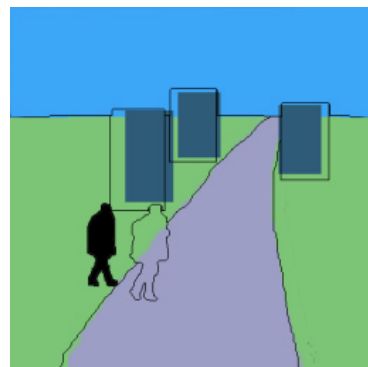

Figure 11: Contours of image t+1 on image t

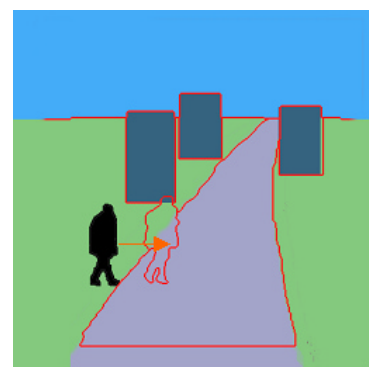

Figure 12: Contours of compensated image t+1 on image t

### Development of radar network, sensors, and ECUs

The ongoing work in the domain of radar concentrates on the complete redesign of the 24 GHz radar sensors to improve the sensitivity to detect vulnerable road users in ranges up to 30m. The entire radar signal processing steps and the radar network processing including low level data fusion (5) are also part of this work.

Till now, the new RF- front end, the digital signal processing hardware and basic software algorithms were implemented. Additional waterproof sensor housings for the redesigned sensors were realised. The first sensor prototypes (wide and narrow beam) were build and first measurements were carried out.

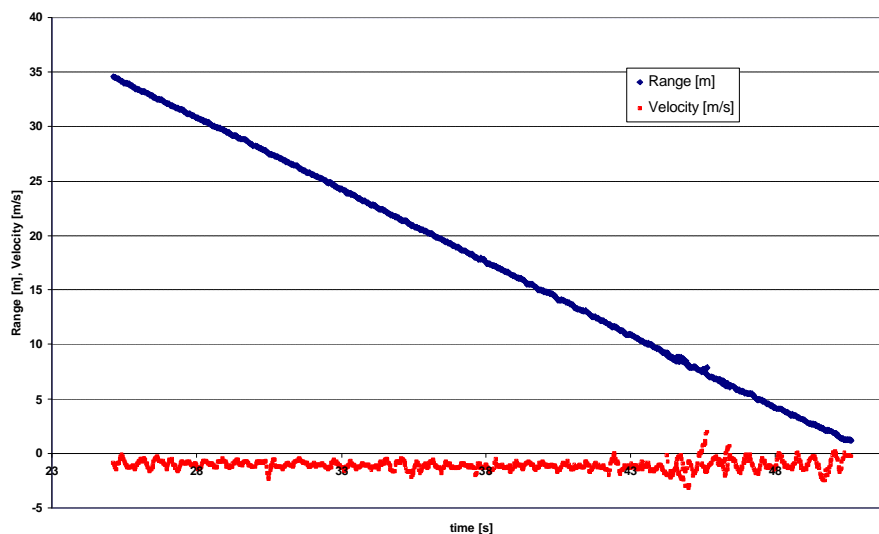

Figure 13: Range/Velocity measurement of the detection of a pedestrian by the first redesigned 24GHz radar sensor prototype (pedestrian comes closer to the sensor)

The important SAVE-U requirements, to improve radar sensor sensitivity for the detection of pedestrians, at ranges up to 30m (pedestrians are weak targets from the radar reflection grade) have been successfully verified and validated. The following graph depicts the range and velocity measurement of the first redesigned 24GHz radar sensor. In Figure 13, a pedestrian was coming from far ranges towards the sensor. As it can be seen that the pedestrian is well detectable at ranges up to approx. 35m.

### **Development of a test method, evaluation**

Evaluation of the SAVE-U sensor platform including the driver warning and vehicle control concepts is one of the major concern too. It is very important for proving the efficiency of the entire approach. As mentioned above, no crash-active protection devices shall be installed on the experimental cars used in this project. Full evaluation of such integrated systems to protect vulnerable road users would require impacting real people (not dummies) due to the required real behaviour with respect to the three sensor technologies deployed. Such kind of testing is clearly unacceptable.

Till now, most of the work was concentrated on the development of dynamic test technique. The concept for the rig shall be a self-propelled, free running, radio-controlled device, with tethers to energy absorbers to prevent impacts to VRU. To ensure a rapid, safe and relatively smooth deceleration (to protect the prototype SAVE-U sensor system) an innovative energy absorption system has been developed.

### **Dissemination**

Most of the results will be made available mainly by means of the web site [www.save-u.org](http://www.save-u.org) (6) and relevant congresses. Among other deliverables and information about SAVE-U, the VRU image database is publicly available through the web site.

### **Conclusion**

SAVE-U is a high performance sensor platform for the active protection of Vulnerable Road Users such as pedestrians and cyclists. SAVE-U project is now running since March 1<sup>st</sup>, 2002. A first important result is the definition of the sensor platform specifications.

It relies on preliminary studies on accident statistics, on human body detection techniques and on possible strategies for VRU protection that have helped in the definition of the main parameters of the sensor platform.

In parallel of the definition of the systems requirements, sensors suppliers are already working on the design and realisation of the 24 GHz radar network and of the image sensors (IR + colour video cameras) with their respective processing ECUs.

It can already be noticed that two different prototypes (wide and narrow beam) of the 24GHz short range radar sensors have been successfully realised. The important SAVE-U requirements, to improve radar sensor sensitivity (at ranges up to 30m) have been successfully verified and validated.

The next step in the project is to get a complete operating sensing platform. For that, partners are working on low level data fusion and processing algorithms. The aim is to get in fine the highest detection rate with the lower false alarm rate, which is a quite difficult challenge.

### **Acknowledgements**

The authors would like to thank the European Commission for supporting this research work under the 5<sup>th</sup> Framework Programme.

### **References**

- (1) Philippe Marchal  
"SAVE-U – Sensors and system Architecture for Vulnerable road User protection"  
eSafety Congress, Lyon - France, Sept 16-18, 2002.

(2) Jean-Jacques Yon; L. Biancardini; E. Mottin; J. L. Tissot; L. Letellier:

“Infrared microbolometer sensors and their application in automotive safety”

7th International Conference on Advanced Microsystems for Automotive Applications (AMAA), Berlin - Germany, May 22-23, 2003.

(3) Dariu M. Gavrilă

“Sensor-based Pedestrian Protection”, IEEE Intelligent Systems, vol.16, nr.6, pp.77-81, 2001.

(4) M. Stanzel, Marc-Michael Meinecke, Marian Andrzej Obojski

“Statistical Analysis of German In-Depth Accident Study (GIDAS)”, April 2002. GIDAS is a joint project of the German Federal Highway Research Institute (BAST) and the German Association for Research on Automobile-Technique (FAT), see Information Brochure, Bergisch Gladbach, Germany, 2000.

(5) Marc-Michael Meinecke, Marian Andrzej Obojski, Matthias Töns, Reiner Doerfler, Philippe Marchal, Laurent Letellier, Dariu Gavrilă, Richard Morris

“Approach for protection of vulnerable road users using sensor fusion techniques”, International Radar Symposium 2003, Dresden – Germany Sept. 30 –Oct. 2, 2003

(6) More information about SAVE-U and deliverables are available for download on <http://www.save-u.org> web site.